

Dell PowerVault MD3260i Series Storage Arrays Deployment Guide



Notes, Cautions, and Warnings



NOTE: A NOTE indicates important information that helps you make better use of your computer.



CAUTION: A CAUTION indicates either potential damage to hardware or loss of data and tells you how to avoid the problem.



WARNING: A WARNING indicates a potential for property damage, personal injury, or death.

© 2013 Dell Inc. All Rights Reserved.

Trademarks used in this text: Dell™, the Dell logo, Dell Boomi™, Dell Precision™, OptiPlex™, Latitude™, PowerEdge™, PowerVault™, PowerConnect™, OpenManage™, EqualLogic™, Compellent™, KACE™, FlexAddress™, Force10™, Venue™ and Vostro™ are trademarks of Dell Inc. Intel®, Pentium®, Xeon®, Core® and Celeron® are registered trademarks of Intel Corporation in the U.S. and other countries. AMD® is a registered trademark and AMD Opteron™, AMD Phenom™ and AMD Sempron™ are trademarks of Advanced Micro Devices, Inc. Microsoft®, Windows®, Windows Server®, Internet Explorer®, MS-DOS®, Windows Vista® and Active Directory® are either trademarks or registered trademarks of Microsoft Corporation in the United States and/or other countries. Red Hat® and Red Hat® Enterprise Linux® are registered trademarks of Red Hat, Inc. in the United States and/or other countries. Novell® and SUSE® are registered trademarks of Novell Inc. in the United States and other countries. Oracle® is a registered trademark of Oracle Corporation and/or its affiliates. Citrix®, Xen®, XenServer® and XenMotion® are either registered trademarks or trademarks of Citrix Systems, Inc. in the United States and/or other countries. VMware®, vMotion®, vCenter®, vCenter SRM™ and vSphere® are registered trademarks or trademarks of VMware, Inc. in the United States or other countries. IBM® is a registered trademark of International Business Machines Corporation.

2013 - 09

Rev. A01

Contents

1 Introduction.....	7
System Requirements.....	7
Management Station Requirements.....	7
Introduction To Storage Arrays.....	7
2 Hardware Installation.....	9
Planning The Storage Configuration	9
Connecting The Storage Array.....	9
Cabling The Storage Array.....	9
Redundant And Non-Redundant Configurations.....	10
Direct-Attached Configurations.....	10
Network-Attached Configurations.....	13
Cabling PowerVault MD3060e Expansion Enclosures.....	16
Expanding With New PowerVault MD3060e Expansion Enclosures.....	16
3 Installing MD Storage Manager.....	17
Modular Disk Configuration Utility.....	18
Graphical Installation (Recommended).....	18
Console Installation	19
Silent Installation	19
Silent Installation On Windows.....	19
Silent Installation On Linux.....	19
Enabling Premium Features (Optional).....	19
Upgrading PowerVault MD Storage Manager.....	19
4 Post Installation Tasks.....	21
Before You Begin.....	21
iSCSI Configuration Terminology.....	21
iSCSI Configuration Worksheet.....	22
Configuring iSCSI On Your Storage Array.....	22
Automatic Configuration Using The Modular Disk Configuration Utility.....	22
Post Connection Establishment Steps.....	24
5 Guidelines For Configuring Your Network For iSCSI.....	25
Microsoft Windows Host Setup.....	25
Using A DHCP server.....	25
Using A Static IP Address.....	25
Using A DNS Server.....	26

Using A WINS Server.....	26
Linux Host Setup.....	26
Using DHCP.....	26
Using A Static IP Address.....	27
6 Uninstalling MD Storage Manager.....	29
Uninstalling MD Storage Manager From Windows.....	29
Uninstall MD Storage Manager From Microsoft Windows Operating Systems Other Than Microsoft	
Windows Server 2008.....	29
Uninstall MD Storage Manager From Windows Server 2008 GUI Versions.....	29
Uninstall MD Storage Manager From Windows Server 2008 Core Versions.....	29
Uninstalling MD Storage Manager From Linux.....	30
7 Appendix — Manual Configuration Of iSCSI.....	31
Step 1: Discover The Storage Array (Out-of-band Management Only).....	31
Default Management Port Settings.....	31
Automatic Storage Array Discovery.....	32
Manual Storage Array Discovery.....	32
Setting Up The Array.....	32
Step 2: Configure The iSCSI Ports On The Storage Array.....	33
Step 3: Perform Target Discovery From The iSCSI Initiator.....	33
For Windows Server 2003 Or Windows Server 2008 GUI Version.....	34
For Windows Server 2008 Core Version.....	34
For Red Hat Enterprise Linux 5 Or 6, SUSE Linux Enterprise Server 10 Or 11.....	34
Step 4: Configure Host Access.....	35
Understanding CHAP Authentication.....	35
What Is CHAP.....	35
Target CHAP.....	36
Mutual CHAP.....	36
CHAP Definitions.....	36
Step 5: Configure CHAP Authentication On The Storage Array (Optional).....	36
Configuring Target CHAP Authentication On The Storage Array.....	36
Configuring Mutual CHAP Authentication On The Storage Array.....	37
Step 6: Configure CHAP Authentication On The Host Server (Optional).....	37
For Windows Server 2008 GUI Version.....	37
For Windows Server 2008 Core Version.....	38
For Red Hat Enterprise Linux 5 Or 6, SUSE Linux Enterprise Server 10 Or 11.....	39
For SUSE Linux Enterprise Server SP3 Using The GUI.....	39
Step 7: Connect To The Target Storage Array From The Host Server.....	40
For Windows Server 2008 GUI Version.....	40
For Windows Server 2008 Core Version.....	40
For Linux Server.....	41

Step 8: (Optional) Set Up In-Band Management.....	42
8 Appendix — Using Internet Storage Naming Service.....	43
9 Appendix — Load Balancing.....	45
Windows Load Balance Policy.....	45
Round Robin With Subset.....	45
Least Queue Depth With Subset.....	45
Changing Load Balance Policies In Windows Sever 2008	45
Changing The Load Balance Policy Using Windows Server 2008 Device Manager Options.....	45
Changing The Load Balance Policy Using The Windows Server 2008 Disk Management Options.....	46
Increasing Bandwidth With Multiple iSCSI Sessions.....	46
10 Appendix — Stopping And Starting iSCSI Services In Linux.....	49
11 IPv4 Settings — Worksheet	51
12 IPv6 Settings — Worksheet	53

Introduction

This guide provides information about deploying Dell PowerVault MD3260i storage arrays. The deployment process includes:

- Hardware installation
- Modular Disk Storage Manager (MD Storage Manager) installation
- Initial system configuration

Other information provided include system requirements, storage array organization, and utilities.

 **NOTE:** For more information on product documentation, see support.dell.com/manuals.

MD Storage Manager enables an administrator to configure and monitor storage arrays for optimum usability. The version of MD Storage Manager included on the PowerVault MD Series resource media can be used to manage both the PowerVault MD3260i Series and other PowerVault MD Series storage arrays. MD Storage Manager is compatible with both Microsoft Windows and Linux operating systems.

System Requirements

Before installing and configuring the PowerVault MD3260i Series hardware and software, ensure that the supported operating system is installed and minimum system requirements are met. For more information, see the Support Matrix at support.dell.com/manuals.

Management Station Requirements

A management station uses MD Storage Manager to configure and manage storage arrays across the network. A management station must meet the following minimum system requirements:

- Intel Pentium or an equivalent processor (1333 MHz or faster) with 512 MB RAM (1024 MB recommended).
- 1 GB disk space.
- Display resolution of 1024x768 with 16 million colors (1280x1024 32-bit recommended).
- Microsoft Windows, Red Hat Enterprise Linux, or SUSE Linux Enterprise Server.

 **NOTE:** Operating system installations can be either native or hypervisor guest configurations.

 **NOTE:** Supported hypervisors include Microsoft Hyper-V, Citrix XenServer, and VMware. For information about the supported versions, see the Support Matrix at support.dell.com/manuals.

- Administrator or equivalent permissions.

Introduction To Storage Arrays

An enclosure containing physical disks accessed through RAID controller modules is called a storage array. A storage array includes various hardware components, such as physical disks, RAID controller modules, fans, and power supplies.

One or more host servers attached to the storage array can access the data on the storage array. You can also establish multiple physical paths between the host(s) and the storage array so that loss of any single path (for example, through failure of a host server port) does not result in loss of access to data on the storage array.

The storage array is managed by MD Storage Manager running on a:

- Host server — On a host server system, MD Storage Manager and the storage array communicate management requests and event information using SAS connections.
- Management station — On a management station, MD Storage Manager communicates with the storage array either through an Ethernet connection to the storage array management port or through an Ethernet connection to a host server. The Ethernet connection passes management information between the management station and the storage array using SAS connections.

Using MD Storage Manager, you can configure the physical disks in the storage array into logical components called disk groups and then divide the disk groups into virtual disks. Disk groups are created in the unconfigured capacity of a storage array. Virtual disks are created in the free capacity of a disk group.

Unconfigured capacity comprises physical disks not already assigned to a disk group. When a virtual disk is created using unconfigured capacity, a disk group is automatically created. If the only virtual disk in a disk group is deleted, the disk group is also deleted. Free capacity is space in a disk group that is not assigned to any virtual disk.

Data is written to the physical disks in the storage array using RAID technology. RAID levels define the way in which data is written to physical disks. Different RAID levels offer different levels of accessibility, redundancy, and capacity. You can set a specified RAID level for each disk group and virtual disk on your storage array. For more information about using RAID and managing data in your storage solution, see the Administrator's Guide at support.dell.com/manuals.

Hardware Installation

Before using this guide, ensure that you review the instructions in the:

- *Getting Started Guide*— The *Getting Started Guide* that shipped with the storage array, provides information to configure the initial setup of the system.
- *Dell PowerVault MD3260/3260i/3660i/3660f/3060e Storage Arrays Administrator's Guide*— The Administrator's Guide provides information about important concepts you must know before setting up your storage solution. See the Administrator's Guide at support.dell.com/manuals.
- The Rack Installation instructions, that shipped with the storage array, provides information on how to rack your system.

Planning The Storage Configuration

Consider the following before installing your storage array:

- Evaluate data storage needs and administrative requirements.
- Calculate availability requirements.
- Decide the frequency and level of backups, such as weekly full backups with daily partial backups.
- Consider storage array options, such as password protection and e-mail alert notifications for error conditions.
- Design the configuration of virtual disks and disk groups according to a data organization plan. For example, use one virtual disk for inventory, a second for financial and tax information, and a third for customer information.
- Decide whether to allow space for hot spares, which automatically replace failed physical disks.

Connecting The Storage Array

The storage array is connected to a host using two hot-swappable RAID controller modules. The RAID controller modules are identified as RAID controller module 0 and RAID controller module 1.

Each RAID controller module has four iSCSI IN port connectors that provide Ethernet connections to the host or node. Each RAID controller module also contains an Ethernet management port and a SAS OUT port connector. The Ethernet management port allows you to install a dedicated management station (server or stand-alone system). The SAS OUT port allows you to connect the storage array to optional expansion enclosures for additional storage capacity.

Each PowerVault MD3260i Series storage array can be expanded to a maximum of 120 (or 180, if enabled using Premium Feature activation) physical disks through a maximum of two PowerVault MD3060e Series expansion enclosures.

Cabling The Storage Array

The iSCSI interface enables different host-to-controller configurations. The figures in this chapter are grouped according to the following categories:

- Direct-attached configurations (no Ethernet switches are used)
- Network-attached (SAN) configurations (Ethernet switches are used)

Redundant And Non-Redundant Configurations

Non-redundant configurations are configurations that provide only a single data path from a host to the storage array. This type of configuration is only recommended for non-critical data storage. Path failure from a failed or removed cable, a failed HBA, or a failed or removed RAID controller module results in loss of host access to storage on the storage array.

Redundancy is established by installing separate data paths between the host and the storage array, in which each path is to one of the two RAID controller modules installed in the storage array. Redundancy protects the host from losing access to data in the event of path failure, because both RAID controller modules can access all the disks in the storage array.

Direct-Attached Configurations

You can connect the Ethernet ports of the host servers directly to the storage array RAID controller module iSCSI ports. The following figure shows eight stand-alone hosts with a single data path.

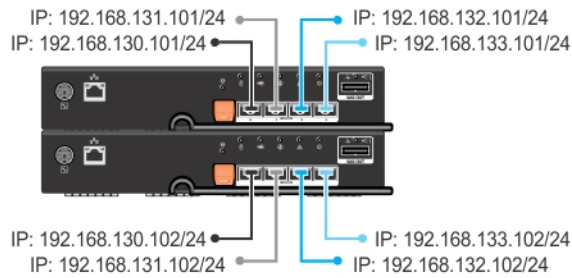
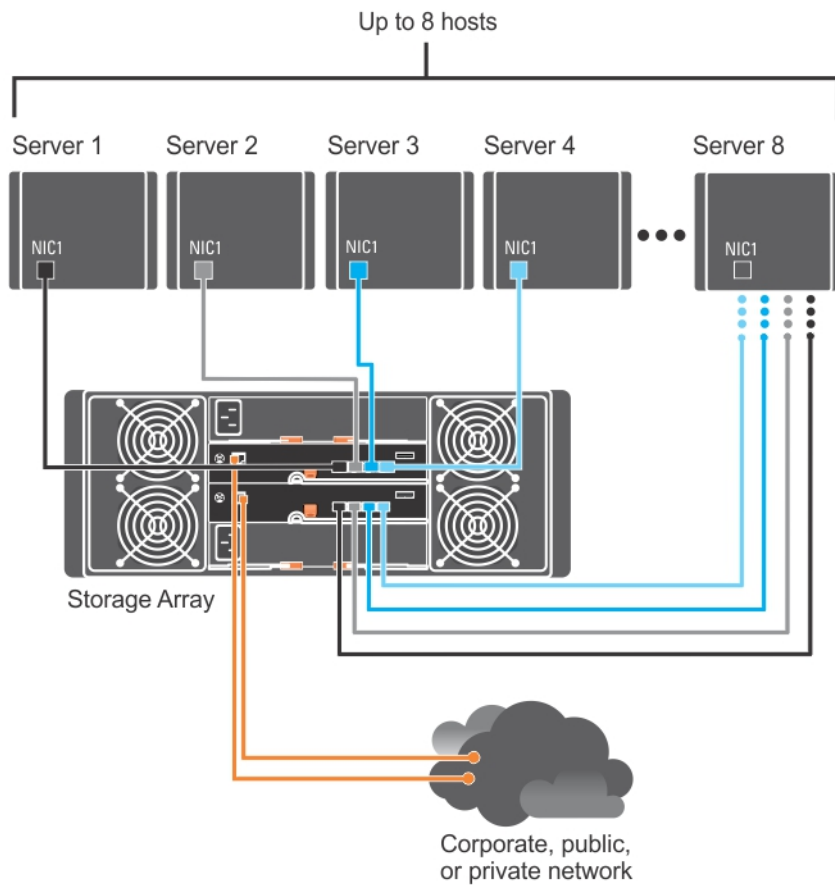

Figure 1. Eight Hosts With a Single Data Path

In the following figure, up to four servers are directly attached to the RAID controller modules. If the host server has a second Ethernet connection to the array, it can be attached to the iSCSI ports on the array's second controller. This configuration provides improved availability by allowing two separate physical paths for each host, which ensures full redundancy if one of the paths fail.

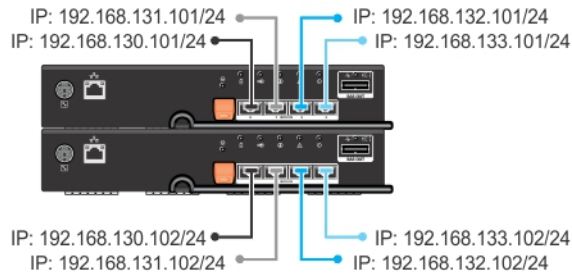
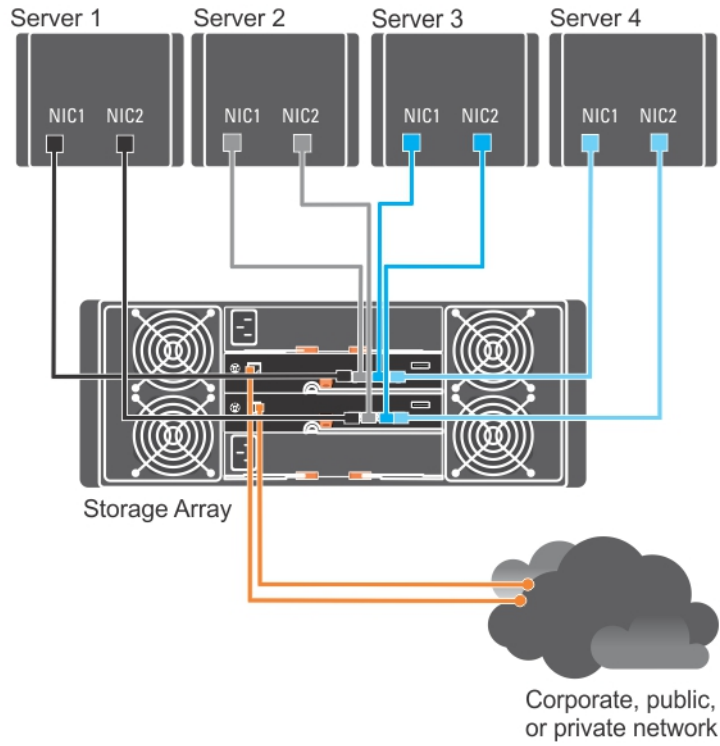

Figure 2. Four Hosts Connected to Two Controllers

In the following figure, up to four cluster nodes are directly attached to two RAID controller modules. Since each cluster node has redundant paths, loss of a single path would still allow access to the to the storage array through the alternate path.

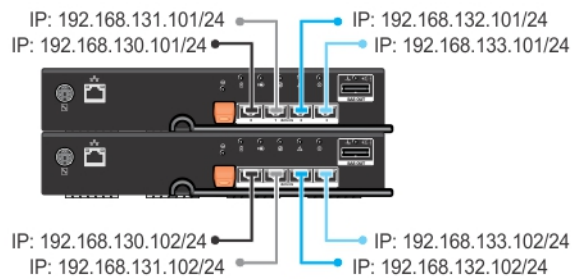
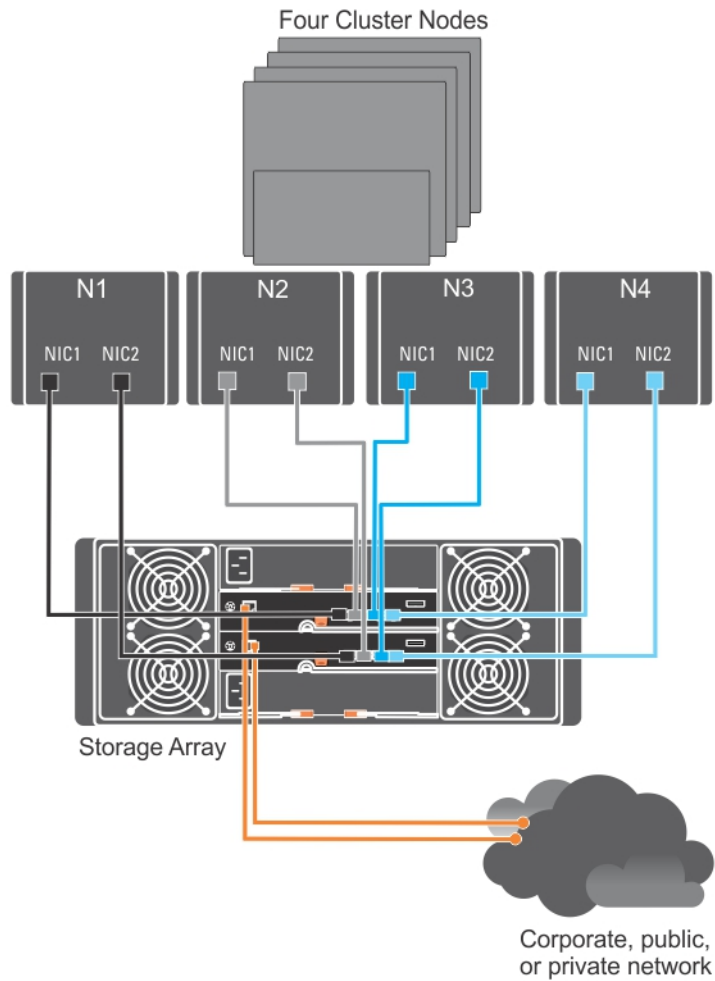

Figure 3. Four Cluster Nodes Connected to Two Controllers

Network-Attached Configurations

You can also cable the host servers to the RAID controller module iSCSI ports through industry-standard 1GB Ethernet switches. An iSCSI configuration that uses Ethernet switches is frequently referred to as an IP SAN. By using an IP SAN,

the PowerVault MD3260i Series storage array can support up to 64 hosts simultaneously. This configuration supports single-path data configurations.

The following figure shows up to 64 stand-alone servers attached (using multiple sessions) to a RAID controller module through a network. Hosts that have a second Ethernet connection to the network allow two separate physical paths for each host, which ensures full redundancy if one of the paths fail.

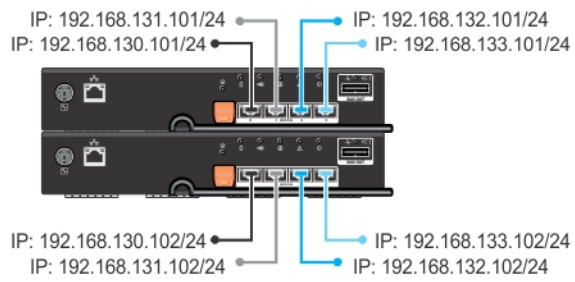
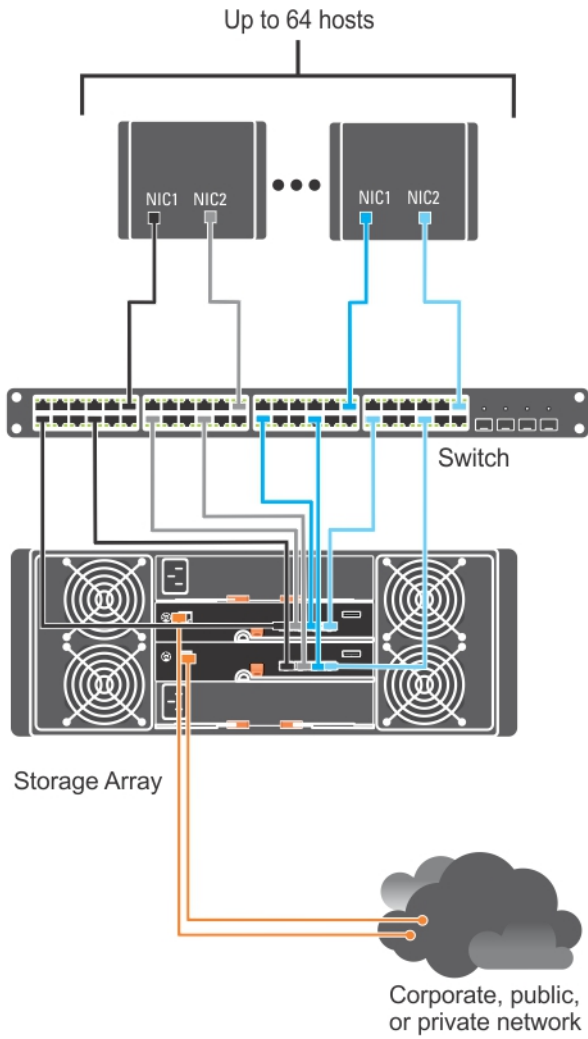

Figure 4. 64 Servers Connected to Two Controllers

Cabling PowerVault MD3060e Expansion Enclosures

You can expand the capacity of your PowerVault MD3260i Series storage array by adding PowerVault MD3060e expansion enclosures. You can expand the physical disk pool to a maximum of 120 (or 180, if enabled using Premium Feature activation) physical disks using a maximum of two expansion enclosures.



NOTE: Hot plug of MD3060e expansion enclosure is not recommended. Power on all MD3060e expansion enclosures before you power on the array enclosure. For helpful videos and other resources on PowerVault MD series, see dell.com/PVresources.

Expanding With New PowerVault MD3060e Expansion Enclosures

Perform the following steps to attach new PowerVault MD3060e expansion enclosures to a PowerVault MD3260i Series storage array:

1. Before adding the expansion enclosure(s), ensure that the storage array software is installed and is up to date. For more information, see the Support Matrix at support.dell.com/manuals.
2. Install the software and driver package included on the PowerVault MD Series resource media. For information about installing the software, see [Installing MD Storage Manager](#).
3. Using **MD Storage Manager**, update the RAID controller module and NVSRAM firmware to the latest versions available on support.dell.com.
4. Click **Tools** → **Upgrade RAID Controller Module Firmware** from the **Enterprise Management Window (EMW)**.
5. Stop all I/O to the storage array and turn off affected host systems attached to the storage array.
6. Turn off the storage array.
7. Turn off any expansion enclosure(s) in the affected system.
8. Cable the expansion enclosure(s) to the storage array.
9. Turn on the expansion enclosure(s) and wait for the enclosure status LED to turn blue.
10. Turn on the storage array and wait for the status LED to indicate that the unit is ready:
 - When power is on, the power on indicator lights solid green.
 - If the Service action required indicator lights amber, there is an error that can be viewed using the PowerVault Modular Disk Storage Manager.
11. After the storage array is online and ready, turn on any attached host systems.
12. Using **PowerVault MD Storage Manager**, update all attached expansion enclosure firmware if it is out of date.
13. From the EMW, select the enclosure that you want to update and launch the **Array Management Window (AMW)**.
14. Select **Upgrade** → **EMM Firmware**.
15. Click **Select All** to update all the attached expansion enclosures simultaneously.
16. Click **Start**.

Installing MD Storage Manager

The PowerVault MD Series resource media contains software and drivers for both Linux and Microsoft Windows operating systems.

The root of the media contains a **readme.txt** file covering changes to the software, updates, fixes, patches, and other important data applicable to both Linux and Windows operating systems. The **readme.txt** file also specifies requirements for accessing documentation, information regarding versions of the software on the media, and system requirements for running the software.

 **CAUTION:** Do not install MD Storage Manager exclusively on a virtual disk that is being actively managed by MD Storage Manager. Instead, install at least one instance of MD Storage Manager on a local disk that is running SMagent and SMmonitor. Installing management software only on a virtual disk may prevent access to recovery information in the event of multiple physical disk or enclosure failures.

For more information on supported hardware and software for Dell PowerVault systems, see the Support Matrix at dell.com/support/manuals.

 **NOTE:** As a first step towards managing the array, always use MD Storage Resource DVD media to update and install MD Storage Manager. For the latest updates and Support Matrix, see dell.com/support/manuals.

The PowerVault MD3260i Series storage firmware installer provides features that include the core software and providers. The core software feature includes the host-based storage agent, multipath driver, and MD Storage Manager application used to configure, manage and monitor the storage array solution. The providers feature include providers for the Microsoft Virtual Disk Service (VDS) and Microsoft Volume Shadow-Copy Service (VSS) framework.

 **NOTE:** For more information about the Microsoft VDS and Microsoft VSS providers, see the Administrator's Guide at dell.com/support/manuals.

 **NOTE:** To install the software on a Windows or Linux system, you must have administrative or root privileges.

 **NOTE:** If Dynamic Host Configuration Protocol (DHCP) is not used, initial configuration of the management station must be performed on the same physical subnet as the storage array. Additionally, during initial configuration, at least one network adapter must be configured on the same IP subnet as the storage array's default management port (192.168.128.101 or 192.168.128.102). After initial configuration, the management ports are configured using MD Storage Manager and the management station's IP address can be changed back to the previous settings.

The PowerVault MD Series resource media offers the following installation methods:

- Graphical Installation (Recommended) — This is the recommended installation procedure. The installer presents a graphical wizard-driven interface that allows customization of which components are installed.
- Console Installation — This installation procedure is useful for Linux users who do not desire to install an X-Window environment on their supported Linux platform.
- Silent Installation — This installation procedure is useful if you prefer to create scripted installations.

Modular Disk Configuration Utility

The PowerVault MD Configuration Utility (MDCU) is an optional utility that provides a consolidated approach for configuring the management and iSCSI host ports, and creating sessions for the iSCSI modular disk storage arrays. It is recommended that you use PowerVault MDCU to configure iSCSI on each host server connected to the storage array.

Graphical Installation (Recommended)

The MD Storage Manager configures, manages, and monitors the storage array. To install the MD storage manager:

1. Insert the PowerVault MD Series resource media.

Depending on your operating system, the installer may launch automatically. If the installer does not launch automatically, navigate to the root directory of the installation media (or downloaded installer image) and run the **md_launcher.exe** file. For Linux-based systems, navigate to the root of the resource media and run the autorun file.

 **NOTE:** By default, Red Hat Enterprise Linux mounts the resource media with the **–noexec** mount option which does not allow you to run executable files. To change this setting, see the **Readme** file in the root directory of the installation media.

2. Select **Install MD Storage Software**.
3. Read and accept the license agreement.
4. Select one of the following installation options from the **Install Set** menu:

- **Full (recommended)** — Installs the MD Storage Manager (client) software, host-based storage agent, multipath driver, and hardware providers.
- **Host Only** — Installs the host-based storage agent and multipath drivers. See [Installing MD Storage Manager](#).
- **Management** — Installs the management software and hardware providers.
- **Custom** — Allows you to select specific components.

 **NOTE:** If you are install the MD Storage Manager on a management station that is not connected to a network or server, only the **Management Station** option is available.

5. Select the PowerVault MD storage array model(s) you are setting up to serve as data storage for this host server.
6. Choose whether to start the event monitor service automatically when the host server reboots or manually.

 **NOTE:** This option is applicable only to Windows client software installation.

7. Confirm the installation location and click **Install**.
8. If prompted, reboot the host server after the installation completes.
9. Start **MD Storage Manager** and discover the array(s).

 **NOTE:** If Dynamic Host Configuration Protocol (DHCP) is not used on the network where the PowerVault MD storage array's management ports are connected, it is recommended that you enable IPv6 on the management station to discover the storage array(s).

 **NOTE:** If automatic discovery does not find the new array, use manual option and provide the default management ports IP addresses 192.168.128.100 and 192.168.128.102 using the same subnet or same VLAN for the MD Storage Manager management station.

10. Configure single initiator and multiple target zoning on your Fibre Channel switches.
11. If applicable, activate any premium features purchased with your storage array. If you purchased premium features, see the printed activation card shipped with your storage array.

 **NOTE:** The **MD Storage Manager** installer automatically installs the required drivers, firmware, and operating system patches/hotfixes to operate your storage array. These drivers and firmware are also available at dell.com/support. In addition, see the Support Matrix at dell.com/support/manuals for any additional settings and/or software required for your specific storage array.

Console Installation

 **NOTE:** Console installation only applies to Linux systems that are not running a graphical environment.

The autorun script in the root of the resource media detects when there is no graphical environment running and automatically starts the installer in a text-based mode. This mode provides the same options as graphical installation.

Silent Installation

Silent Installation On Windows

To run silent installation on a Windows system:

1. Copy the **custom_silent.properties** file in the **/windows** folder of the installation media or image to a writable location on the host server.
2. Modify the **custom_silent.properties** file to reflect the features, models and installation options to be used. Then, save the file.
3. After the **custom_silent.properties** file is revised to reflect your specific installation, run the following command to begin the silent installation:

```
mdss_install.exe -f <host_server_path>\ custom_silent.properties
```

Silent Installation On Linux

To run silent installation on a Linux system:

 **NOTE:** On Red Hat Enterprise Linux 6 operating systems, run the following script from the root directory to install prerequisite packages:

```
# md_prereq_install.sht
```

1. Copy the **custom_silent.properties** file in the **/windows** folder of the installation media or image to a writable location on the host server.
2. Modify the **custom_silent.properties** file to reflect the features, models and installation options to be used. Then, save the file.
3. After the **custom_silent.properties** file is revised, run the following command to begin the installation:

```
./mdss_install.bin -f <host_server_path>/custom_silent.properties
```

Enabling Premium Features (Optional)

If you ordered premium features, follow the instructions on the Premium Features card to install the additional features.

Upgrading PowerVault MD Storage Manager

To upgrade from a previous version of the PowerVault MD Storage Manager, uninstall the previous version (see [Uninstalling MD Storage Manager](#)), and then follow the instructions in [Installing MD Storage Manager](#) to install the new version.

Post Installation Tasks

Before using the storage array for the first time, complete a number of initial configuration tasks in the order shown. These tasks are performed using the MD Storage Manager.

-  **NOTE:** If Dynamic Host Configuration Protocol (DHCP) is not used, initial configuration using the management station must be performed on the same physical subnet as the storage array. Additionally, during initial configuration, at least one network adapter must be configured on the same IP subnet as the storage array's default management port (192.168.128.101 or 192.168.128.102). After initial configuration, the management ports are configured using MD Storage Manager and the management station's IP address can be changed back to the previous settings.

Before You Begin

-  **NOTE:** Before you begin configuring iSCSI, it is recommended that you fill out the IPv4 or IPv6 iSCSI configuration worksheet available in this document. Gathering this type of information about your network before starting the configuration steps helps you to complete the process more efficiently.

iSCSI Configuration Terminology

Term	Definition
CHAP (Challenge Handshake Authentication Protocol)	Access to an iSCSI storage system by restricting use of the iSCSI data ports on both the host server and storage array. For more information on the types of CHAP authentication supported, see Understanding CHAP Authentication .
Host or host server	A server connected to the storage array using iSCSI ports.
Host server port	SCSI port on the host server used to connect it to the storage array.
iSCSI initiator	The iSCSI-specific software installed on the host server that controls communications between the host server and the storage array.
iSCSI host port	The iSCSI port (two per controller) on the storage array.
iSNS (Microsoft Internet Storage Naming Service)	An automated discovery, management and configuration (Storage Naming Service) tool used by some iSCSI devices.
Management station	The system from which you manage your host server/storage array configuration.
Storage array	The enclosure containing the storage data accessed by the host server.
Target	An iSCSI port on the storage array that accepts and responds to requests from the iSCSI initiator installed on the host server.

iSCSI Configuration Worksheet

The [IPv4 Settings — Worksheet](#) and [IPv6 Settings — Worksheet](#) helps you plan your configuration. Recording host server and storage array IP addresses at a single location enables you to configure your setup faster and more efficiently.

[Guidelines For Configuring Your Network For iSCSI](#) provides general network setup guidelines for both Windows and Linux environments. It is recommended that you review these guidelines before completing the worksheet.

Configuring iSCSI On Your Storage Array

The following sections contain step-by-step instructions for configuring iSCSI on your storage array. However, before you begin, it is important to understand where each of these steps occur in relation to your host server or storage array environment.

The following table shows each iSCSI configuration step and where it occurs.

Table 1. Host Server Vs. Storage Array

This Step is Performed on the Host Server Using the Microsoft or Linux iSCSI Initiator	This Step is Performed on the Storage Array Using PowerVault MD Storage Manager
	1. Discover the storage array
	2. Configure the iSCSI ports on the storage array
3. Perform target discovery from the iSCSI initiator	
	4. Configure host access
	5. (Optional) Configure CHAP authentication on the storage array
6. (Optional) Configure CHAP authentication on the host server	
7. Connect to the storage array from the host server	
	8. (Optional) Set up in-band management

 **NOTE:** It is recommended that you use the PowerVault Modular Disk Configuration Utility (MDCU) for iSCSI configuration. The PowerVault MDCU wizards guides you through the configuration steps described above. If you want to perform a manual configuration, see [Appendix — Manual Configuration of iSCSI](#).

Automatic Configuration Using The Modular Disk Configuration Utility

 **NOTE:** If PowerVault MDCU is not installed, it can be installed from the PowerVault MD Series resource media.

PowerVault MDCU provides a consolidated approach for configuring the iSCSI network of host servers and iSCSI-based storage arrays using a wizard-driven interface. This utility also enables the user to configure the iSCSI sessions of the host server according to the best practices and to achieve load-balanced paths with the storage array iSCSI host ports. If you select **Launch the MDCU** after reboot during the installation of the host software, the utility automatically launches after the next host server reboot. This utility can also be launched manually.

The utility has a context sensitive online help to guide you through each step of the wizard.

The PowerVault MDCU performs:

- Storage array configuration

- Host configuration

Storage Array Configuration

Before a host iSCSI initiator and an iSCSI-based storage array can communicate, they must be configured with information such as which IP addresses and authentication method to use. Since iSCSI initiators establish connections with an already configured storage array, the first task is to configure your storage arrays to make them available for iSCSI initiators.

This utility requires network access to the management ports of the storage arrays you wish to configure. You must have a properly functioning network infrastructure before attempting to configure your storage arrays. If your storage arrays are already configured, you can skip directly to the host configuration.

This configuration task generally involves the following steps:

1. Discover available storage array(s) for configuration.
2. Select a storage array to configure.
3. Set a storage array name and password.
4. Configure the IP protocols and addresses for the management ports.
5. Configure the IP protocols and addresses for the iSCSI ports.
6. Specify the CHAP authentication method.
7. Apply the settings after reviewing the summary.
8. Repeat the procedure starting from step 2 to configure additional arrays.

Host Configuration (Host Connectivity Configuration)

After you have completed configuring your iSCSI-based storage arrays, the next task is to run this utility on all hosts that need to access the storage arrays. Depending on your network configuration, your host may be the same machine you use to manage your storage arrays, or it may be on a completely separate network.

The option to configure a host is disabled if the machine the utility is running on does not have an iSCSI initiator or the required driver components installed. When the option is disabled, the utility also displays an informational message. If you are running the utility on a host which is not connected to the iSCSI based storage array (or which you do not wish to connect to the array), the informational message can be ignored.

The task involves the following steps:

1. Discover available storage array(s) for connection.
2. Select a storage array.
3. Specify the CHAP secret.
4. Select the iSCSI ports the host's initiator uses to log on.
5. Repeat the process starting from step 2 to connect to additional arrays.
6. Repeat these steps on each host that needs access to the storage array(s).

Before Starting The Configuration Process

Before you start configuring the storage array or host connectivity, it is recommended that you fill out the iSCSI configuration worksheet to help you plan your configuration. You may need to use several worksheets depending on your configuration.

Keep the following guidelines in mind for the storage array and host configuration:

- For optimal performance, ensure your network configuration is valid. See the storage array's *Support Matrix* at support.dell.com/manuals.
- If your host has multiple network interfaces, it is recommended that each network interface uses a separate subnet.

- For redundancy in a dual controller (duplex) configuration, ensure each host network interface is configured to connect to both storage array controllers.
- For optimal load balancing, ensure each host network interface that is used for iSCSI traffic is configured to connect to each storage array controller.
- It is recommended that each host network interface only establishes one iSCSI session per storage array controller.

 **NOTE:** The utility tries to follow the guidelines for the host connectivity whenever possible based on the available host network interfaces and their connectivity with the iSCSI host ports of the storage array.

Configure The Storage Array Using PowerVault MDCU

To configure the iSCSI-based storage array(s) using PowerVault MDCU:

1. Launch the utility (if it is not launched automatically) from the server with access to the management ports of the storage array(s) to be configured.
 - For Windows, click **Start** → **All Programs** → **Dell** → **MD Storage Software** → **Modular Disk Configuration Utility**.
 - For Linux, click the **MDCU** icon on the desktop or navigate to the `/opt/dell/mdstoragesoftware/mdconfigurationutility` directory in a terminal window and run **PowerVault MDCU**.

The MDCU automatically discovers all the available storage arrays.

2. In the **Discover MD Arrays** window, select the iSCSI storage array you want to configure.
3. In the **Selected Array** window, review current port and session information.
4. Click **Config Wizard**, to start the iSCSI configuration wizard.
5. Complete the steps in **Config Wizard** to configure your iSCSI storage array.
6. In the **Array Configuration Summary** window, review and apply your configuration settings.
7. Click **Create iSCSI Sessions**, to create host-to-storage array communication.
Repeat for all host-to-array mappings you want to implement.
8. Verify that communication is established between the storage array and host server.

 **NOTE:** For more information on MDCU, see the MDCU online help.

Post Connection Establishment Steps

After iSCSI connectivity is established between the host server(s) and the storage array, you can create virtual disks on the storage array using MD Storage Manager and these virtual disks can be utilized by the host server(s). For more information about storage planning and using MD Storage Manager, see the Administrator's Guide at support.dell.com/manuals.

Guidelines For Configuring Your Network For iSCSI

This section provides general guidelines for setting up your network environment and IP addresses for use with the iSCSI ports on your host server and storage array. Your specific network environment may require different or additional steps than shown here, so make sure you consult with your system administrator before performing this setup.

Microsoft Windows Host Setup

To set up a Windows host network, you must configure the IP address and netmask of each iSCSI port connected to the storage array. The specific steps depend on whether you are using a Dynamic Host Configuration Protocol (DHCP) server, static IP addressing, Domain Name System (DNS) server, or Windows Internet Name Service (WINS) server.

 **NOTE:** The server IP addresses must be configured for network communication to the same IP subnet as the storage array management and iSCSI ports.

Using A DHCP server

If you are using a DHCP server:

1. In the **Control Panel**, select **Network connections or Network and Sharing Center** and then click **Manage network connections**.
2. Right-click the network connection you want to configure and select **Properties**.
3. On the **General** tab (for a local area connection) or the **Networking** tab (for all other connections), select Internet Protocol (TCP/IP), and then click **Properties**.
4. Select **Obtain an IP address automatically**, then click **OK**.

Using A Static IP Address

If you are using a static IP address (root users only):

1. Edit the **/etc/sysconfig/network** file as follows:

```
NETWORKING=yes
HOSTNAME=mymachine.mycompany.com
GATEWAY=255.255.255.0
```
2. Edit the configuration file for the connection you want to configure, either **/etc/sysconfig/network-scripts/ifcfg-ethX** (for Red Hat Enterprise Linux) or **/etc/sysconfig/network/ifcfg-eth-id-XX:XX:XX:XX:XX** (for SUSE Enterprise Linux).

```
BOOTPROTO=static BROADCAST=192.168.1.255
IPADDR= 192.168.1.100
NETMASK=255.255.255.0
NETWORK= 192.168.1.0
ONBOOT=yes TYPE=Ethernet
HWADDR=XX:XX:XX:XX:XX:XX
GATEWAY=192.168.1.1
```

3. Restart network services using the following command:

```
/etc/init.d/network restart
```

Using A DNS Server

If you are using static IP addressing:

1. In the **Control Panel**, select **Network connections** or **Network and Sharing Center** and then click **Manage network connections**.
2. Right-click the network connection you want to configure and select **Properties**.
3. On the **General** tab (for a local area connection) or the **Networking** tab (for all other connections), select **Internet Protocol (TCP/IP)**, and then click **Properties**.
4. Select **Obtain DNS server address automatically** or enter the preferred and alternate DNS server IP addresses and click **OK**.

Using A WINS Server

If you are using static IP addressing:

 **NOTE:** If you are using a DHCP server to allocate WINS server IP addresses, you do not need to add WINS server addresses.

1. In the **Control Panel**, select **Network connections**.
2. Right-click the network connection you want to configure and select **Properties**.
3. On the **General** tab (for a local area connection) or the **Networking** tab (for all other connections), select **Internet Protocol (TCP/IP)**, and then click **Properties**.
4. Select **Advanced** → **WINS** tab and click **Add**.
5. In the **TCP/IP WINS server** window, type the IP address of the WINS server and click **Add**.
6. To enable use of the **Lmhosts** file to resolve remote NetBIOS names, select **Enable LMHOSTS lookup**.
7. To specify the location of the file that you want to import into the **Lmhosts** file, select **Import LMHOSTS** and then select the file in the **Open** dialog box.
8. Enable or disable NetBIOS over TCP/IP.

If using Microsoft Windows Server 2008 Core Version, use the `netsh` interface command to configure the iSCSI ports on the host server.

Linux Host Setup

To set up a Linux host network, you must configure the IP address and netmask of each iSCSI port connected to the storage array. The specific steps depend on whether you are configuring TCP/IP using DHCP or configuring TCP/IP using a static IP address.

 **NOTE:** The server IP addresses must be configured for network communication to the same IP subnet as the storage array management and iSCSI ports.

Using DHCP

If you are using DHCP (root users only):

1. Edit the `/etc/sysconfig/network` file:

```
NETWORKING=yes HOSTNAME=mymachine.mycompany.com
```

2. Edit the configuration file for the connection you want to configure, either `/etc/sysconfig/network-scripts/ifcfg-ethX` (for Red Hat Enterprise Linux) or `/etc/sysconfig/network/ifcfg-eth-id-XX:XX:XX:XX:XX` (for SUSE Enterprise Linux).

```
BOOTPROTO=dhcpm
```

Also, verify that an IP address and netmask are not defined.

3. Restart network services using the following command:

```
/etc/init.d/network restart
```

Using A Static IP Address

If you are using a static IP address (root users only):

1. Edit the `/etc/sysconfig/network` file as follows:

```
NETWORKING=yes  
HOSTNAME=mymachine.mycompany.com  
GATEWAY=255.255.255.0
```

2. Edit the configuration file for the connection you want to configure, either `/etc/sysconfig/network-scripts/ifcfg-ethX` (for Red Hat Enterprise Linux) or `/etc/sysconfig/network/ifcfg-eth-id-XX:XX:XX:XX:XX` (for SUSE Enterprise Linux).

```
BOOTPROTO=static BROADCAST=192.168.1.255  
IPADDR= 192.168.1.100  
NETMASK=255.255.255.0  
NETWORK= 192.168.1.0  
ONBOOT=yes TYPE=Ethernet  
HWADDR=XX:XX:XX:XX:XX:XX  
GATEWAY=192.168.1.1
```

3. Restart network services using the following command:

```
/etc/init.d/network restart
```

Uninstalling MD Storage Manager

Uninstalling MD Storage Manager From Windows

Uninstall MD Storage Manager From Microsoft Windows Operating Systems Other Than Microsoft Windows Server 2008

Use the **Change/Remove Program** feature to uninstall the Modular Disk Storage Manager from Microsoft Windows operating systems other than Microsoft Windows Server 2008. To uninstall the Modular Disk Storage Manager from Microsoft Windows Server 2008:

1. Double-click **Add or Remove Programs** from the **Control Panel**.
2. Select **Dell MD3260i** storage software from the list of programs.
3. Click **Change/Remove**.
The **Uninstall Complete** window is displayed.
4. Follow the instructions on screen.
5. Select **Yes** to restart the system, and then click **Done**.

Uninstall MD Storage Manager From Windows Server 2008 GUI Versions

To uninstall Modular Disk Storage Manager from Windows Server 2008 GUI versions:

1. Double-click **Programs and Features** from the **Control Panel**.
2. Select **MD Storage Software** from the list of programs.
3. Click **Uninstall/Change**.
The **Uninstall Complete** window is displayed.
4. Follow the instructions on screen.
5. Select **Yes** to restart the system, then click **Done**.

Uninstall MD Storage Manager From Windows Server 2008 Core Versions

To uninstall PowerVault Modular Disk Storage Manager on Windows Server 2008 Core versions:

1. Navigate to the **Dell\MD Storage Software\Uninstall Dell Modular Disk MD3260i Storage Software** directory.
 **NOTE:** By default, MD Storage Manager is installed in the **\Program Files\Dell\MD Storage Software** directory. If another directory was used during installation, navigate to that directory before beginning the uninstallation procedure.
2. From the installation directory, type the following command and press <Enter>:
`Uninstall Modular Disk Storage`
3. From the **Uninstall** window, click **Next** and follow the instructions on the screen.
4. Select **Yes** to restart the system, then click **Done**.

Uninstalling MD Storage Manager From Linux

By default, PowerVault MD Storage Manager is installed in the `/opt/dell/mdstoragemanager` directory. If another directory was used during installation, navigate to that directory before beginning the uninstallation procedure.

1. From the installation directory, open the **Uninstall Dell MD Storage Software** directory.
2. Run the file **Uninstall Dell MD Storage Software.exe**.
3. From the **Uninstall** window, click **Next**, and follow the instructions on the screen.
While the software is uninstalling, the **Uninstall** window is displayed. When the uninstall procedure is complete, the **Uninstall Complete** window is displayed.
4. Click **Done**.

Appendix — Manual Configuration Of iSCSI

The following sections contain step-by-step instructions for configuring iSCSI on your storage array. However, before beginning, it is important to understand where each of these steps occur in relation to your host server or storage array environment.

The table below shows each iSCSI configuration step and where it occurs.



This Step is Performed on the Host Server Using the Microsoft or Linux iSCSI Initiator	This Step is Performed on the Storage Array Using PowerVault MD Storage Manager
	1. Discover the storage array
	2. Configure the iSCSI ports on the storage array
3. Perform target discovery from the iSCSI initiator	4. Configure host access
	5. (Optional) Configure CHAP authentication on the storage array
6. (Optional) Configure CHAP authentication on the host server	
7. Connect to the storage array from the host server	8. (Optional) Set up in-band management

Step 1: Discover The Storage Array (Out-of-band Management Only)

Default Management Port Settings

By default, the storage array management ports are set to Dynamic Host Configuration Protocol (DHCP). If the controllers on your storage array are unable to get IP configuration from a DHCP server, it times out after 10 seconds and falls back to a default static IP address. The default IP configuration is:

```
Controller 0: IP: 192.168.128.101 Subnet Mask: 255.255.255.0
Controller 1: IP: 192.168.128.102 Subnet Mask: 255.255.255.0
```

-  **NOTE:** No default gateway is set.
-  **NOTE:** If DHCP is not used, initial configuration using the management station must be performed on the same physical subnet as the storage array. Additionally, during initial configuration, at least one network adapter must be configured on the same IP subnet as the storage array's default management port (192.168.128.101 or 192.168.128.102). After initial configuration (management ports are configured using PowerVault MD Storage Manager), the management station's IP address can be changed back to its previous settings.
-  **NOTE:** This procedure applies to out-of-band management only. If you choose to set up in-band management, you must complete this step and then see [Step 8: \(Optional\) Set Up In-Band Management](#).

You can discover the storage array either automatically or manually.

Automatic Storage Array Discovery

1. Launch **MD Storage Manager**.
If this is the first storage array to be set up, the **Add New Storage Array** window is displayed.
2. Select **Automatic** and click **OK**.
After discovery is complete, a confirmation screen is displayed. It may take several minutes for the discovery process to complete. Closing the discovery status window before the discovery process completes cancels the discovery process.
3. Click **Close** to close the screen.

Manual Storage Array Discovery

1. Launch **MD Storage Manager**.
If this is the first storage array to be set up, the **Add New Storage Array** window is displayed.
2. Select **Manual** and click **OK**.
3. Select **Out-of-band management** and enter the host server name(s) or IP address(es) of the iSCSI storage array controller.
4. Click **Add**.
Out-of-band management is successfully configured.
5. After discovery is complete, a confirmation screen is displayed. Click **Close** to close the screen.

Setting Up The Array

 **NOTE:** Before configuring the storage array, check the status icons on the **Summary** tab to ensure that the enclosures in the storage array are in an Optimal status. For more information on the status icons, see the Administrator's Guide at support.dell.com/manuals.

1. When discovery is complete, the name of the first storage array found is displayed under the **Summary** tab in MD Storage Manager.
2. The default name for the newly discovered storage array is **Unnamed**. If another name is displayed, click the down arrow next to that name and select **Unnamed** in the drop-down list.
3. Click the **Initial Setup Tasks** option to see links to the remaining post-installation tasks. For more information about each task, see the Administrator's Guide at support.dell.com/manuals. Perform these tasks in the order shown in the following table.

Task	Purpose
Rename the storage array	To provide a more meaningful name than the software-assigned label, Unnamed.
Set a storage array password	To restrict unauthorized access. MD Storage Manager may ask for a password before changing the configuration or performing a destructive operation.
Set up alert notifications	To notify individuals (by e-mail) and/or storage enterprise management consoles, such as Dell Management Console, (by SNMP) when a storage array component degrades or fails, or an adverse environmental condition occurs.
Set up e-mail alerts	
Set up SNMP alerts	

Task	Purpose
Configure a storage array	To create virtual disks and map them to hosts.

Step 2: Configure The iSCSI Ports On The Storage Array

By default, the iSCSI ports on the storage array are set to the following IPv4 settings:

```
Controller 0, Port 0: IP: 192.168.130.101 Subnet Mask: 255.255.255.0 Port: 3260
Controller 0, Port 1: IP: 192.168.131.101 Subnet Mask: 255.255.255.0 Port: 3260
Controller 0, Port 2: IP: 192.168.132.101 Subnet Mask: 255.255.255.0 Port: 3260
Controller 0, Port 3: IP: 192.168.133.101 Subnet Mask: 255.255.255.0 Port: 3260
Controller 1, Port 0: IP: 192.168.130.102 Subnet Mask: 255.255.255.0 Port: 3260
Controller 1, Port 1: IP: 192.168.131.102 Subnet Mask: 255.255.255.0 Port: 3260
Controller 1, Port 2: IP: 192.168.132.102 Subnet Mask: 255.255.255.0 Port: 3260
Controller 1, Port 3: IP: 192.168.133.102 Subnet Mask: 255.255.255.0 Port: 3260
```

 **NOTE:** No default gateway is set.

To configure the iSCSI ports on the storage array:

1. From MD Storage Manager navigate to the **Setup** tab on the AMW. Click **configure Ethernet management ports** and then select **Configure iSCSI Host Ports**.
2. Configure the iSCSI ports on the storage array.

 **NOTE:** Using static IPv4 addressing is recommended, although DHCP is supported.

The following settings are available (depending on your specific configuration) by clicking the Advanced button:

- Virtual LAN (VLAN) support — A VLAN is a network of different systems that behave as if they are connected to the same segments of a local area network (LAN) and are supported by the same switches and routers. When configured as a VLAN, a device can be moved to another location without being reconfigured. To use VLAN on your storage array, obtain the VLAN ID from your network administrator and enter it here.
- Ethernet priority — This parameter is set to determine a network access priority.
- TCP listening port — The port number on the storage array listens for iSCSI logins from host server iSCSI initiators.

 **NOTE:** The TCP listening port for the iSNS server is the port number the storage array controller uses to connect to an iSNS server. This allows the iSNS server to register the iSCSI target and portals of the storage array so that the host server initiators can identify them.

- Jumbo frames — Jumbo Ethernet frames are created when the maximum transmission units (MTUs) are larger than 1500 Bytes per frame. This setting is adjustable port-by-port.
3. To enable ICMP PING responses for all ports, select **Enable ICMP PING responses**.
 4. Click **OK** when all iSCSI storage array port configurations are complete.
 5. Test the connection for each iSCSI storage array port.

Step 3: Perform Target Discovery From The iSCSI Initiator

This step identifies the iSCSI ports on the storage array to the host server. Select the set of steps in one of the following sections (Microsoft Windows or Linux) that corresponds to your operating system.

For Windows Server 2003 Or Windows Server 2008 GUI Version

1. Click **Start**→ **Programs**→ **Microsoft iSCSI Initiator** or click **Start**→ **All Programs**→ **Administrative Tools**→ **iSCSI Initiator**.
 2. Click the **Discovery** tab.
 3. Under **Target Portals**, click **Add** and enter the IP address or DNS name of the iSCSI port on the storage array.
 4. If the iSCSI storage array uses a custom TCP port, change the **Port** number.
The default is 3260.
 5. Click **Advanced** and set the following values on the **General** tab:
 - **Local Adapter** — Must be set to Microsoft iSCSI Initiator.
 - **Source IP** — The source IP address of the host you want to connect with.
 - **Data Digest** and **Header Digest** — Optionally, you can specify that a digest of data or header information be compiled during transmission to assist in troubleshooting.
 - **CHAP logon information** — Leave this option unselected and do not enter CHAP information at this point, unless you are adding the storage array to a SAN that has target CHAP already configured.
-  **NOTE:** IPsec is not supported.
6. Click **OK** to exit the **Advanced** menu and click **OK** again to exit the **Add Target Portals** screen.
 7. To exit the **Discovery** tab, click **OK**.

If you plan to configure CHAP authentication, do not perform discovery on more than one iSCSI port at this point. Go to [Step 4: Configure Host Access](#).

If you do not plan to configure CHAP authentication, repeat step 1 through step 6 for all iSCSI ports on the storage array.

For Windows Server 2008 Core Version

1. Set the iSCSI initiator service to start automatically:

```
sc <<server_name> config msiscsi start= auto
```
2. Start the iSCSI service:

```
sc start msiscsi
```
3. Add a target portal:

```
iscsicli QAddTargetPortal  
<IP_address_of_iSCSI_port_on_storage_array>
```

For Red Hat Enterprise Linux 5 Or 6, SUSE Linux Enterprise Server 10 Or 11

Configuration of the iSCSI initiator for Red Hat Enterprise Linux 5 and SUSE Linux Enterprise Server 10 SP1 distributions is done by modifying the `/etc/iscsi/iscsid.conf` file, which is installed by default when you install MD Storage Manager. You can edit the file directly, or replace the default file with a sample file included on the PowerVault MD series resource media.

To use the sample file included on the resource media:

1. Save the **default/etc/iscsi/iscsid.conf** file by naming it to another name of your choice.
2. Copy the appropriate sample file from **/linux/etc** on the media to **/etc/iscsi/iscsid.conf**.
3. Rename the sample file to **iscsid.conf**.
4. Edit the following entries in the **/etc/iscsi/iscsid.conf** file:

- a) Edit or verify that the `node.startup = manual` line is disabled.
 - b) Edit or verify that the `node.startup = automatic` line is enabled.
This enables automatic startup of the service at boot time.
 - c) Verify that the following time-out value is set to 30 by running the following command:
`node.session.timeo.replacement_timeout = 30`
 - d) Save and close the `/etc/iscsi/iscsid.conf` file.
5. From the console, restart the iSCSI service with the following command:
`service iscsi start`
 6. Verify that the iSCSI service is running during boot using the following command from the console:
`chkconfig iscsi on`
 7. To display the available iSCSI targets at the specified IP address, use the following command:
`iscsiadm -m discovery -t st -p <IP_address_of_iSCSI_port>`
 8. After target discovery, use the following command to manually log in:
`iscsiadm -m node -l`

This log in is performed automatically at startup if automatic startup is enabled.
 9. Manually log out of the session using the following command:
`iscsiadm -m node -T <initiator_username> -p <target_ip> -u`

Step 4: Configure Host Access

This step specifies which host servers access virtual disks on the storage array. You should perform this step:

- Before mapping virtual disks to host servers
 - Any time you connect new host servers to the storage array
1. Launch MD Storage Manager.
 2. Navigate to the AMW and click **Manually define hosts**.
 3. At **Enter host name**, enter the host server for virtual disk mapping.
This can be an informal name, not necessarily a name used to identify the host server to the network.
 4. Select a method for adding the host port identifier
 5. Select the host type.
 6. Select whether or not the host server will be part of a host server group that shares access to the same virtual disks as other host servers. Select **Yes** only if the host is part of a Microsoft cluster.
 7. Click **Next**.
 8. Specify if this host will be part of a host group.
 9. Click **Finish**.

Understanding CHAP Authentication

What Is CHAP

Challenge Handshake Authentication Protocol (CHAP) is an optional iSCSI authentication method where the storage array (target) authenticates iSCSI initiators on the host server. Two types of CHAP are supported:

- Target CHAP
- Mutual CHAP

Target CHAP

In target CHAP, the storage array authenticates all requests for access issued by the iSCSI initiator(s) on the host server using a CHAP secret. To set up target CHAP authentication, you must enter a CHAP secret on the storage array, then configure each iSCSI initiator on the host server to send that secret each time it attempts to access the storage array.

Mutual CHAP

In addition to setting up target CHAP, you can set up mutual CHAP in which both the storage array and the iSCSI initiator authenticate each other. To set up mutual CHAP, configure the iSCSI initiator with a CHAP secret that the storage array must send to the host sever in order to establish a connection. In this two-way authentication process, both the host server and the storage array send information that the other must validate before a connection is allowed.

CHAP is an optional feature and is not required to use iSCSI. However, if you do not configure CHAP authentication, any host server connected to the same IP network as the storage array can read from and write to the storage array.

 **NOTE:** When using CHAP authentication, you should configure it on both the storage array (using MD Storage Manager) and the host server (using the iSCSI initiator) before preparing virtual disks to receive data. If you prepare disks to receive data before you configure CHAP authentication, you lose visibility to the disks once CHAP is configured.

CHAP Definitions

To summarize the differences between target CHAP and mutual CHAP authentication, see the following table.

CHAP Type	Description
Target CHAP	Sets up accounts that iSCSI initiators use to connect to the target storage array. The target storage array then authenticates the iSCSI initiator.
Mutual CHAP	Applied in addition to target CHAP, mutual CHAP sets up an account that a target storage array uses to connect to an iSCSI initiator. The iSCSI initiator then authenticates the target.

Step 5: Configure CHAP Authentication On The Storage Array (Optional)

If you are not configuring any type of CHAP, skip these steps and go to [Step 7: Connect To The Target Storage Array From The Host Server](#).

 **NOTE:** If you choose to configure mutual CHAP authentication, you must first configure target CHAP.

In terms of iSCSI configuration, the term Target always refers to the storage array.

Configuring Target CHAP Authentication On The Storage Array

1. From **MD Storage Manager**, click the **iSCSI** tab and then click **Change Target Authentication**.
Select one of the CHAP settings described in the following table.

CHAP Setting	Description
None	This is the default selection. If None is the only selection, the storage array allows an iSCSI initiator to log on without supplying any type of CHAP authentication.
None and CHAP	The storage array allows an iSCSI initiator to log on with or without CHAP authentication.
CHAP	If CHAP is selected and None is deselected, the storage array requires CHAP authentication before allowing access.

- To configure a CHAP secret, select **CHAP** and select **CHAP Secret**.
- Enter the **Target CHAP Secret** (or **Generate Random Secret**). Confirm it in **Confirm Target CHAP Secret** and click **OK**. Although the storage array allows sizes from 12 to 57 characters, many initiators only support CHAP secret sizes up to 16 characters (128-bit).

 **NOTE:** A CHAP secret is not retrievable after it is entered. Ensure that you record the secret in an accessible place. If Generate Random Secret is used, copy and paste the secret into a text file for future reference since the same CHAP secret is used to authenticate any new host servers you may add to the storage array. If you forget this CHAP secret, you must disconnect all existing hosts attached to the storage array and repeat the steps in this chapter to add them again.

- Click **OK**.

Configuring Mutual CHAP Authentication On The Storage Array

The initiator secret must be unique for each host server that connects to the storage array and must not be the same as the target CHAP secret.

Change the initiator authentication settings in the **Change Target Authentication** window. Use these options to change the settings:

- None** — Select **None** if you permit no initiator authentication. If you select **None**, any initiator can access this target. Use this option only if you do not require secure data. However, you can select both **None** and **CHAP** at the same time.
- CHAP** — Select **CHAP** if you want to enable an initiator that tries to access the target to authenticate using CHAP. Define the CHAP secret only if you want to use mutual CHAP authentication. If you select **CHAP**, and if no CHAP target secret is defined, an error message is displayed. Click **CHAP Secret** to view the **Enter CHAP Secret** windows. Use this window to define the CHAP secrets.

 **NOTE:** To remove a CHAP secret, you must delete the host initiator and add it again.

Step 6: Configure CHAP Authentication On The Host Server (Optional)

If you configured CHAP authentication in Step 5: Configure CHAP Authentication on the Storage Array (Optional), complete the following steps. If not, skip to Step 7: Connect to the Target Storage Array From the Host Server.

Select the set of steps in one of the following sections (Windows or Linux) that corresponds to your operating system.

For Windows Server 2008 GUI Version

- Click **Start** → **Programs** → **Microsoft iSCSI Initiator** or click **Start** → **All Programs** → **Administrative Tools** → **iSCSI Initiator**.
- If you are not using mutual CHAP authentication, go to the step 4.

3. If you are using mutual CHAP authentication, click the **General** tab and select **Secret**. At **Enter a secure secret**, enter the mutual CHAP secret you entered for the storage array
4. Click the **Discovery** tab.
5. Under **Target Portals**, select the IP address of the iSCSI port on the storage array and click **Remove**. The iSCSI port you configured on the storage array during target discovery disappears.
6. Under **Target Portals**, click **Add** and re-enter the IP address or DNS name of the iSCSI port on the storage array (removed above).
7. Click **Advanced** and set the following values on the **General** tab:
 - **Local Adapter** — Should always be set to Microsoft iSCSI Initiator.
 - **Source IP** — The source IP address of the host you want to connect with.
 - **Data Digest and Header Digest** — Optionally, you can specify that a digest of data or header information be compiled during transmission to assist in troubleshooting.
 - **CHAP logon information** — Enter the target CHAP authentication user name and secret you entered (for the host server) on the storage array.
 - **Perform mutual authentication** — If mutual CHAP authentication is configured, select this option.

 **NOTE:** IPsec is not supported.

8. Click **OK**.
If you require a discovery session failover, repeat step 5 and step 6 (in this step) for all iSCSI ports on the storage array. Otherwise, single-host port configuration is sufficient.

 **NOTE:** If the connection fails, ensure that all IP addresses are entered correctly. Mistyped IP addresses result in connection problems.

For Windows Server 2008 Core Version

1. Set the iSCSI initiator services to start automatically (if not already set):
`sc \\`
2. Start the iSCSI service (if necessary):
`sc start msiscsi`
3. If you are not using mutual CHAP authentication, go to step 5.
4. Enter the mutual CHAP secret you entered for the storage array:
`iscsicli CHAPSecret <secret>`
5. Remove the target portal that you configured on the storage array during target discovery:
`iscsicli RemoveTargetPortal <IP_address>
<TCP_listening_port>`
6. Add the target portal with CHAP defined:
`iscsicli QAddTargetPortal
<IP_address_of_iSCSI_port_on_storage_array>
[CHAP_username]
[CHAP_password]`

Where, [CHAP_username] is the initiator name and [CHAP_password] is the target CHAP secret.

If you require a discovery session failover, repeat step 5 for all iSCSI ports on the storage array. Otherwise, single-host port configuration is sufficient.

For Red Hat Enterprise Linux 5 Or 6, SUSE Linux Enterprise Server 10 Or 11

1. To enable CHAP (optional), the following line needs to be enabled in your `/etc/iscsi/iscsid.conf` file:

```
node.session.auth.authmethod = CHAP
```
2. To set a user name and password for CHAP authentication of the initiator by the target(s), edit the following lines:

```
node.session.auth.username = <iscsi_initiator_username>  
node.session.auth.password = <CHAP_initiator_password>
```
3. If you are using Mutual CHAP authentication, you can set the user name and password for CHAP authentication of the target(s) by the initiator by editing the following lines:

```
node.session.auth.username_in=<iscsi_target_username>  
node.session.auth.password_in =<CHAP_target_password>
```
4. To set up discovery session CHAP authentication, first uncomment the following line:

```
discovery.sendtargets.auth.authmethod = CHAP
```
5. Set a user name and password for a discovery session CHAP authentication of the initiator by the target(s) by editing the following lines:

```
discovery.sendtargets.auth.username =<iscsi_initiator_username>  
discovery.sendtargets.auth.password =<CHAP_initiator_password>
```
6. To set the user name and password for discovery session CHAP authentication of the target(s) by the initiator for Mutual CHAP, edit the following lines:

```
discovery.sendtargets.auth.username = <iscsi_target_username>  
discovery.sendtargets.auth.password_in = <CHAP_target_password>
```
7. The final configuration contained in the `/etc/iscsi/iscsid.conf` file may look like this:

```
node.session.auth.authmethod = CHAP  
node.session.auth.username = iqn.2005-03.com.redhat01.78b1b8cad821  
node.session.auth.password = password_1  
node.session.auth.username_in= iqn.1984-05.com.dell:powervault.123456  
node.session.auth.password_in = test1234567890  
discovery.sendtargets.auth.authmethod = CHAP  
discovery.sendtargets.auth.username = iqn.2005-03.com.redhat01.78b1b8cad821  
discovery.sendtargets.auth.password = password_1  
discovery.sendtargets.auth.username = iqn.1984-05.com.dell:powervault.123456  
discovery.sendtargets.auth.password_in = test1234567890
```

For SUSE Linux Enterprise Server SP3 Using The GUI

1. Click **Desktop**→ **YaST**→ **iSCSI Initiator**.
2. Click **Service Start**, then select **When Booting**.
3. Select **Discovered Targets**, then select **Discovery**.
4. Enter the IP address of the port.
5. Click **Next**.
6. Select any target that is not logged in and click **Log in**.
7. Select one of the following:
 - If you are not using CHAP authentication, select **No Authentication**. Go to step 8.
 - or
 - If you are using CHAP authentication, enter the CHAP user name and password. To enable Mutual CHAP, select and enter the Mutual CHAP user name and password.
8. Repeat step 7 for each target until at least one connection is logged in for each controller.

9. Go to **Connected Targets**.
10. Verify that the targets are connected and the status is **true**.

Step 7: Connect To The Target Storage Array From The Host Server

For Windows Server 2008 GUI Version

1. Click **Start** → **Program** → **Microsoft iSCSI Initiator** or **Start** → **All Programs** → **Administrative Tools** → **iSCSI Initiator**.
2. Click the **Targets** tab.
If previous target discovery was successful, the IQN of the storage array should be displayed under **Targets**.
3. Click **Log On**.
4. Select **Automatically restore this connection when the system boots**.
5. Select **Enable multi-path**.
6. Click **Advanced** and configure the following settings under the **General** tab:
 - **Local Adapter** — Must be set to Microsoft iSCSI Initiator.
 - **Source IP** — The source IP address of the host server you want to connect from.
 - **Target Portal** — Select the iSCSI port on the storage array controller that you want to connect to.
 - **Data Digest** and **Header Digest** — Optionally, you can specify that a digest of data or header information be compiled during transmission to assist in troubleshooting.
 - **CHAP logon information** — If CHAP authentication is required, select this option and enter the Target secret.
 - **Perform mutual authentication** — If mutual CHAP authentication is configured, select this option.

 **NOTE:** IPsec is not supported

7. Click **OK**.
To support storage array controller failover, the host server must be connected to at least one iSCSI port on each controller. Repeat step 3 through step 8 for each iSCSI port on the storage array that you want to establish as failover targets. The Target Portal address is different for each port you connected to.

 **NOTE:** To enable the higher throughput of multipathing I/O, the host server must connect to both iSCSI ports on each controller, ideally from separate host-side NICs. Repeat step 3 through step 7 for each iSCSI port on each controller. If using a duplex PowerVault MD3260i configuration, then LUNs must also be balanced between the controllers.

The **Status** field on the **Targets** tab should now display as **Connected**.

8. Click **OK** to close the Microsoft iSCSI initiator.

 **NOTE:** PowerVault MD3260i supports only round robin load-balancing policies.

For Windows Server 2008 Core Version

If you are using Windows Server 2008 Core Version:

1. Set the iSCSI initiator services to start automatically (if not already set):

```
sc \\<server_name> config msiscsi start= auto
```
2. Start the iSCSI service (if necessary):

```
sc start msiscsi
```

3. Log on to the target:

```
iscsicli PersistentLoginTarget Target_Name
Report_To_PNP Target_Portal_Address
TCP_Port_Number_Of_Target_Portal * * *
Login_Flags * * * * * Username Password
Authtype * Mapping_Count
```

where

- <Target_Name> is the target name as displayed in the target list. Use the iscsicli ListTargets command to display the target list.
 - <Report_To_PNP > is T, which exposes the LUN to the operating system as a storage device.
 - <Target_Portal_Address> is the IP address of the iSCSI port on the controller being logged in to.
 - <TCP_Port_Number_Of_Target_Portal> is 3260.
 - <Login_Flags> is 0x2 to enable multipathing for the target on the initiator. This value allows more than one session to be logged in to a target at one time.
 - <Username> is the initiator name.
 - <Password> is the target CHAP secret.
 - <Authtype> is either 0 for no authentication, 1 for Target CHAP, or 2 for Mutual CHAP.
-  **NOTE:** <Username>, <Password>, and <Authtype> are optional parameters. They can be replaced with an asterisk (*) if CHAP is not used.
- <Mapping_Count> is 0, indicating that no mappings are specified and no further parameters are required.

*** An asterisk (*) represents the default value of a parameter.

For example, your log on command may look like this:

```
iscsicli PersistentLoginTarget iqn.1984-
05.com.dell:powervault.6001372000ffe3332xx0000046
72edf2 3260 T 192.168.130.101 * * * 0x2 * * * * * * * * 0
```

To view active sessions to the target, run the following command:

```
iscsicli SessionList
```

To support storage array controller failover, the host server must be connected to at least one iSCSI port on each controller. Repeat step 3 for each iSCSI port on the storage array that you want to establish as a failover target. The Target_Portal_Address is different for each port you connect to.

PersistentLoginTarget does not initiate a login to the target until after the system is rebooted. To establish immediate login to the target, substitute LoginTarget for PersistentLoginTarget.

 **NOTE:** See the *Microsoft iSCSI Software Initiator 2.x User's Guide* for more information about the commands used in the previous steps. For more information about Windows Server 2008 Server Core, see the Microsoft Developers Network (MSDN) at microsoft.com.

For Linux Server

In MD Storage Manager, the **Configure iSCSI Host Ports** displays the status of each iSCSI port you attempt to connect and the configuration state of all IP addresses. If either displays **Disconnected** or **Unconfigured** respectively, check the following and repeat the iSCSI configuration steps:

- Are all cables securely attached to each port on the host server and storage array?
- Is TCP/IP correctly configured on all target host ports?
- Is CHAP set up correctly on both the host server and the storage array?

To review optimal network setup and configuration settings, see [Guidelines For Configuring Your Guidelines For Configuring Your Network For iSCSI](#).

Step 8: (Optional) Set Up In-Band Management

Out-of-band management (see Step 1: Discover the Storage Array (Out-of-band Management Only)) is the recommended method for managing the storage array. However, to optionally set up in-band management, use the steps shown below.

The default iSCSI host port IPv4 addresses are displayed below for reference:

```
Controller 0, Port 0: IP: 192.168.130.101 Controller 0, Port 1: IP:
192.168.131.101
Controller 0, Port 0: IP: 192.168.132.101 Controller 0, Port 1: IP:
192.168.133.101
Controller 1, Port 0: IP: 192.168.130.102 Controller 1, Port 1: IP:
192.168.131.102
Controller 1, Port 0: IP: 192.168.132.102 Controller 1, Port 1: IP:
192.168.133.102
```



NOTE: The management station you are using must be configured for network communication to the same IP subnet as the PowerVault MD3260i host ports.

1. Establish an iSCSI session to the PowerVault MD3260i RAID storage array.
2. Restart the **SMagent** service.
3. Launch MD Storage Manager.
If this is the first storage array to be set up for management, the **Add New Storage Array** window is displayed. Otherwise, click **New**.
4. Select **Manual** and click **OK**.
5. Select In-band management and enter the host server name(s) or IP address(es) of the host server that is running the PowerVault MD Storage Manager.
6. Click **Add**.
In-band management should now be successfully configured.

Appendix — Using Internet Storage Naming Service

Internet Storage Naming Service (iSNS) server, supported only on Microsoft Windows iSCSI environments, eliminates the need to manually configure each individual storage array with a specific list of initiators and target IP addresses. Instead, iSNS automatically discovers, manages, and configures all iSCSI devices in your environment.

For more information on iSNS, including installation and configuration, see microsoft.com.

Appendix — Load Balancing

Windows Load Balance Policy

Multi-path drivers select the I/O path to a virtual disk through a specific RAID controller module. When the multi-path driver receives a new I/O, the driver tries to find a path to the current RAID controller module that owns the virtual disk. If that path cannot be found, the multi-path driver migrates the virtual disk ownership to the secondary RAID controller module. When multiple paths to the RAID controller module that owns the virtual disk exist, you can choose a load balance policy to determine which path is used to process I/O. Multiple options for setting the load balance policies let you optimize I/O performance when mixed host interfaces are configured.

You can choose one of the following load balance policies to optimize I/O performance:

- Round robin with subset
- Least queue depth with subset

Round Robin With Subset

The round-robin with subset I/O load balance policy routes I/O requests, in rotation, to each available data path to the RAID controller module that owns the virtual disks. This policy treats all paths to the RAID controller module that owns the virtual disk equally for I/O activity. Paths to the secondary RAID controller module are ignored until ownership changes. The basic assumption for the round-robin policy is that the data paths are equal. With mixed host support, the data paths may have different bandwidths or different data transfer speeds.

Least Queue Depth With Subset

The least queue depth with subset policy is also known as the least I/Os, or least requests policy. This policy routes the next I/O request to a data path that has the least outstanding I/O requests queued. For this policy, an I/O request is simply a command in the queue. The type of command or the number of blocks that are associated with the command are not considered. The least queue depth with subset policy treats large block requests and small block requests equally. The data path selected is in the path group of the RAID controller module that owns the virtual disk.

Changing Load Balance Policies In Windows Server 2008

Load balancing with the PowerVault MD3260i series is only available for Windows Server 2008 or later versions of the operating system. You can change the load balance policies from the default round robin with subset by using one of the following:

- Device Manager options
- Disk Management options

Changing The Load Balance Policy Using Windows Server 2008 Device Manager Options

1. From the host desktop, right-click **My Computer** and select **Manage**.

The **Computer Management** window is displayed.

2. Click **Device Manager** to show the list of devices attached to the host.
3. Right-click the multi-path disk device for which you want to set load balance policies, then select **Properties**.
4. From the **MPIO** tab, select the load balance policy you want to set for this disk device.

Changing The Load Balance Policy Using The Windows Server 2008 Disk Management Options

1. From the host desktop, right-click **My Computer** and select **Manage**.
The **Computer Management** window is displayed.
2. Click **Disk Management** to show the list of virtual disks attached to the host.
3. Right-click the virtual disk on which you want to set the load balance policy, then click **Properties**.
4. From the **MPIO** tab, select the load balance policy that you want to set for this virtual disk.

Increasing Bandwidth With Multiple iSCSI Sessions

The PowerVault MD3260i Series storage array in a duplex configuration supports two active/active asymmetric redundant controllers. Each controller has four 1 Gbps Ethernet ports that support iSCSI. The bandwidth of the four ports on the same controller can be aggregated to provide optimal performance. A host can be configured to simultaneously use the bandwidth of both the ports on a controller to access virtual disks owned by the controller. The multi-path failover driver that Dell provides for the MD3260i Series storage array can be used to configure the storage array so that all ports are used for simultaneous I/O access. If the multi-path driver detects multiple paths to the same virtual disk through the ports on the same controller, it load-balances I/O access from the host across all ports on the controller.

The following figure illustrates how the initiator can be configured to take advantage of the load balancing capabilities of the multi-path failover driver.

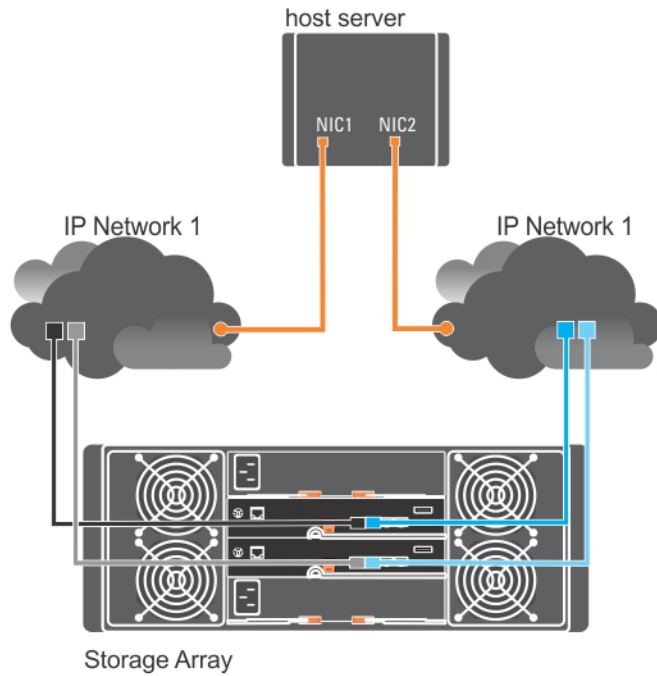

IP Addresses

Host
 If1: IP_Addr_If1
 If2: IP_Addr_If2

MD3260i Controller 0

P0: IP_Addr_C0_P0
 P1: IP_Addr_C0_P1
 P2: IP_Addr_C0_P2
 P3: IP_Addr_C0_P3

MD3260i Controller 1

P0: IP_Addr_C1_P0
 P1: IP_Addr_C1_P1
 P2: IP_Addr_C1_P2
 P3: IP_Addr_C1_P3

TCP Connections

To MD3260i Controller 0

T01: IP_Addr_If1 / IP_Addr_C0_P0
 T02: IP_Addr_If2 / IP_Addr_C1_P1
 T03: IP_Addr_If3 / IP_Addr_C1_P2
 T04: IP_Addr_If4 / IP_Addr_C1_P3

To MD3260i Controller 1

T11: IP_Addr_If1 / IP_Addr_C1_P0
 T12: IP_Addr_If2 / IP_Addr_C1_P1
 T13: IP_Addr_If3 / IP_Addr_C1_P2
 T14: IP_Addr_If4 / IP_Addr_C1_P3

iSCSI Sessions

To MD3260i Controller 0

Session 00: T01
 Session 01: T02
 Session 02: T03
 Session 03: T04

To MD3260i Controller 1

Session 10: T11
 Session 11: T12
 Session 12: T13
 Session 13: T14

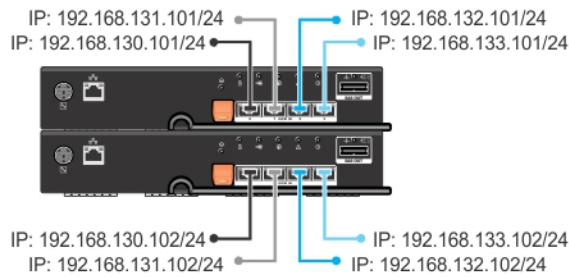

Figure 5. Initiator Configuration

Two sessions with one TCP connection are configured from the host to each controller (one session per port), for a total of four sessions. The multi-path failover driver balances I/O access across the sessions to the ports on the same controller. In a duplex configuration, with virtual disks on each controller, creating sessions using each of the iSCSI data ports of both controllers increases bandwidth and provides load balancing.

Appendix — Stopping And Starting iSCSI Services In Linux

To manually stop the iSCSI services in Linux, certain steps must be followed to maintain parallel processing between the storage array and the host server.

1. Stop all I/O.
2. Unmount all correlated file systems.
3. Stop iSCSI service by running the following command:
`/etc/init.d/open-iscsi stop`

IPv4 Settings — Worksheet

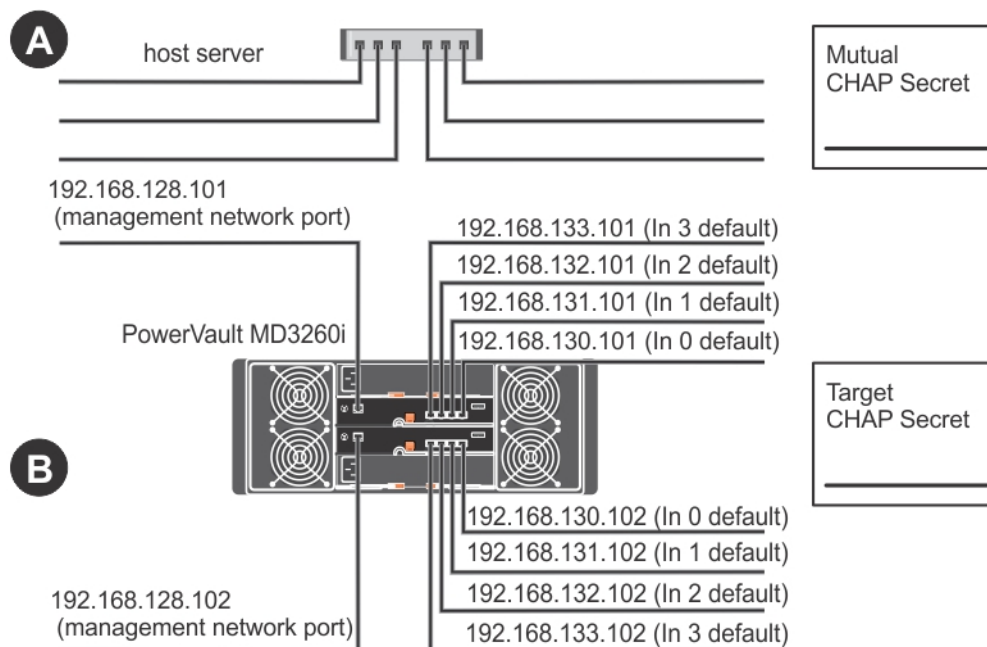

NOTE: If you need additional space for more than one host server, use an additional sheet.

A	Static IP address (host server)	Subnet A (must be different for each NIC)	Default gateway
iSCSI port 1	___ . ___ . ___ . ___	___ . ___ . ___ . ___	___ . ___ . ___ . ___
iSCSI port 2	___ . ___ . ___ . ___	___ . ___ . ___ . ___	___ . ___ . ___ . ___
iSCSI port 3	___ . ___ . ___ . ___	___ . ___ . ___ . ___	___ . ___ . ___ . ___
iSCSI port 4	___ . ___ . ___ . ___	___ . ___ . ___ . ___	___ . ___ . ___ . ___
Management port	___ . ___ . ___ . ___	___ . ___ . ___ . ___	___ . ___ . ___ . ___
Management port	___ . ___ . ___ . ___	___ . ___ . ___ . ___	___ . ___ . ___ . ___

B	Static IP address (host server)	Subnet A (must be different for each NIC)	Default gateway
iSCSI port 0, In 0	___ . ___ . ___ . ___	___ . ___ . ___ . ___	___ . ___ . ___ . ___
iSCSI port 0, In 1	___ . ___ . ___ . ___	___ . ___ . ___ . ___	___ . ___ . ___ . ___

B

	Static IP address (host server)	Subnet A (must be different for each NIC)	Default gateway
iSCSI port 0, ln 2	___ . ___ . ___ . ___	___ . ___ . ___ . ___	___ . ___ . ___ . ___
iSCSI port 0, ln 3	___ . ___ . ___ . ___	___ . ___ . ___ . ___	___ . ___ . ___ . ___
Management port cntrl 0	___ . ___ . ___ . ___	___ . ___ . ___ . ___	___ . ___ . ___ . ___
iSCSI port 1, ln 0	___ . ___ . ___ . ___	___ . ___ . ___ . ___	___ . ___ . ___ . ___
iSCSI port 1, ln 1	___ . ___ . ___ . ___	___ . ___ . ___ . ___	___ . ___ . ___ . ___
iSCSI port 1, ln 2	___ . ___ . ___ . ___	___ . ___ . ___ . ___	___ . ___ . ___ . ___
iSCSI port 1, ln 3	___ . ___ . ___ . ___	___ . ___ . ___ . ___	___ . ___ . ___ . ___
Management port cntrl 1	___ . ___ . ___ . ___	___ . ___ . ___ . ___	___ . ___ . ___ . ___

IPv6 Settings — Worksheet

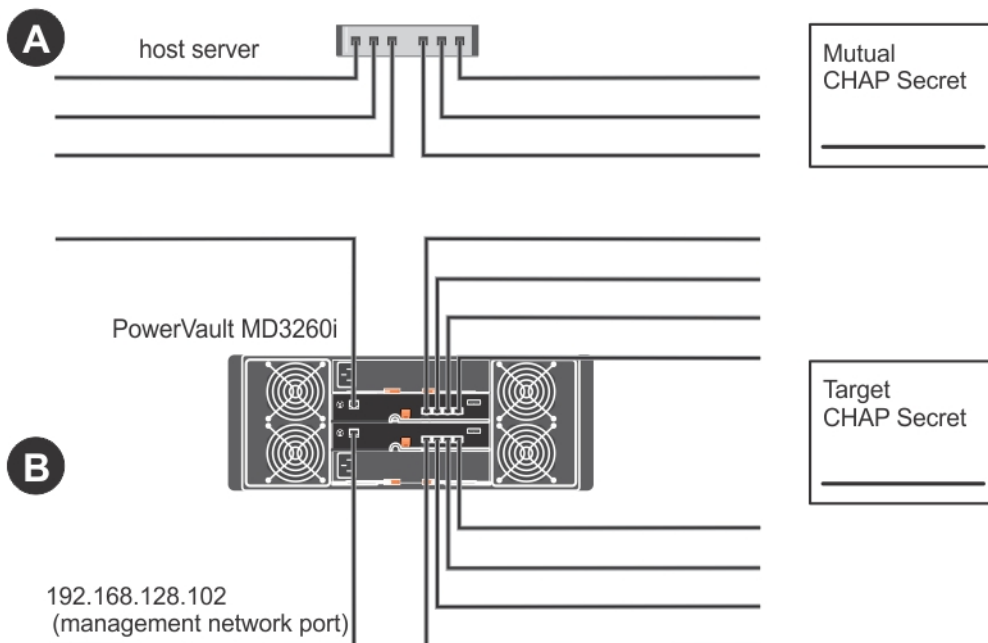

NOTE: If you need additional space for more than one host server, use an additional sheet.

A	Host iSCSI port 1	Host iSCSI port 2	
Link local IP address	___ . ___ . ___ . ___	Link local IP address	___ . ___ . ___ . ___
Routable IP address	___ . ___ . ___ . ___	Routable IP address	___ . ___ . ___ . ___
Subnet prefix	___ . ___ . ___ . ___	Subnet prefix	___ . ___ . ___ . ___
Gateway	___ . ___ . ___ . ___	Gateway	___ . ___ . ___ . ___

B

iSCSI controller 0, In 0

IP address FE80 : 0000 : 0000 : 0000 : ____ : ____ : ____ : ____

Routable IP address 1 ____ : ____ : ____ : ____ : ____ : ____ : ____ : ____

Routable IP address 2 ____ : ____ : ____ : ____ : ____ : ____ : ____ : ____

iSCSI controller 1, In 3

IP address FE80 : 0000 : 0000 : 0000 : ____ : ____ : ____ : ____
Routable IP address 1 ____ : ____ : ____ : ____ : ____ : ____ : ____ : ____
Routable IP address 2 ____ : ____ : ____ : ____ : ____ : ____ : ____ : ____
Router IP address ____ : ____ : ____ : ____ : ____ : ____ : ____ : ____